

FULFILLING EXPECTATIONS WITHOUT EXCUSE

WELDING MACHINE  
WELDING ROBOT  
LASER CUTTING MACHINE  
ABRASIVE  
SAFETY EQUIPMENT  
POWER TOOLS  
HAND TOOLS  
CNC / VMC MACHINE  
HYDRAULIC SHEARING MACHINE  
AIR COMPRESSOR  
BLOWER  
TESTING/MEASURING EQUIPMENT  
SCIENTIFIC INSTRUMENTS  
CHEMICAL MACHINE  
GEAR BOX  
ELEVATOR  
CRAN / HOIST  
CASTER WHEEL / TROLLEY WHEEL  
VALVE & VALVE  
CONVEYOR SYSTEM  
ELECTRIC MOTOR  
LIGHTING POLE  
TRANSFORMER  
CONTROL PANEL  
ELECTRICAL SWITCHGEAR  
CABLE  
UPS/INVERTER  
LED LIGHT  
WEIGHTING SCALE  
WATER PURIFIER  
CURRENCY COUNTING MACHINE

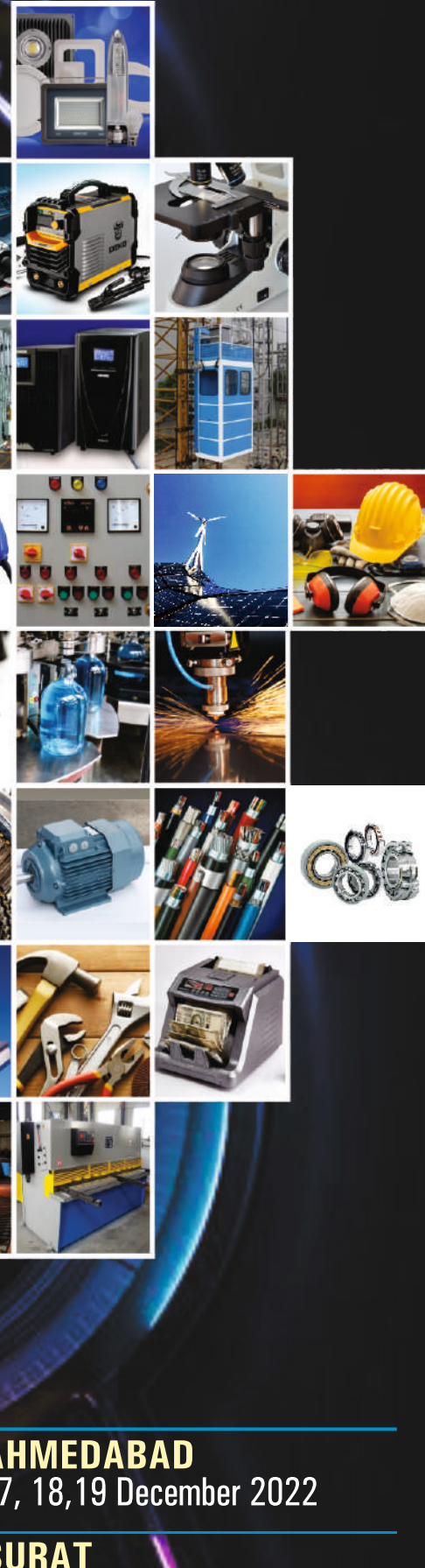

A MEGA INDUSTRIAL EXHIBITION



- 9TH** AHMEDABAD  
17, 18, 19 December 2022
- 10TH** SURAT  
18, 19, 20 February 2023
- 11TH** RAJKOT  
17, 18, 19, 20, December 2023
- 12TH** VADODARA  
17, 18, 19, February 2024

300+Stalls • Exhibitors & Visitors & Visitors from Across India Subjective Domes • 50000 + Expected Visitors



**ENGIEXPO** has Emerged as Prestigious Brand in Field of Exhibitions and Trade-fair. with this Consecutive and Successful MEGA Event with Tremendous Support and Response from the Industries, **ENGIEXPO** Started Getting National Recognition for Depicting Entire Value Chain for Engineering Industries with focused Approach. More than **500+** Exhibitors/ Participants from Across India and Thousands of Business Visitors in MEGA **ENGIEXPO**, has Scripted a Phenomenal Growth path for **ENGIEXPO** towards International Exhibition. We Believe in Creating **BRAND** value, Support Product Market and Enhance Sustainability even in worldwide worst Economic Scenario for Exhibitors and Participants by Unlocking the Unmatched Potentials & Opportunities for the Industries. **MAKE IN INDIA, INDIA FIRST, DIGITAL INDIA, STARTUP INDIA** and **BRAND INDIA** are the Root Objectives of our Mission.

With the Vision of Go Nationally International and Cover all Segments During the years ahead, 2 Way Advertising Continuously working day and night to scale up the **ENGIEXPO** to a New height for threshold Industries. For Growth Towards being Global and Strong Sustainability, Marketing and Advertisement Emerged as lifeline for all Industries.

## 'LET THE WORLD KNOW, THE BEST IN OUR EXHIBITORS'.

We are Committed to Provide the Upgraded, Dynamic and a Real Platform to Untape the huge Potentials Market, Unlock the Unexplored Opportunities & Technological Upgradations with Sole Motive of Creating a Competitive edge and Value Additions for our Exhibitors and Participants. We are also Committed to keep Exploring other Activities to Support our Exhibitors and to do Necessary Research work in the field of Effective and Fruitful Marketing & Advertisement.

We look forward to the Continuous Patronage of all of you to Create a Milestone for you and Thanks for being with us with full trust, Support, Valuable Guidance and well wishing.

# Highlights



**Our Mission keeps us Focused and Accountable, our Vision Drives us and our Values dictates how we succeed. To best understand How we are Different, It has Specific Objectives for the Exhibitors Participating in this Exhibition, which are listed below :**

- **1,00,000 Sq. Mtr. Area Covered By ENGIEXPO.**
- **30 Persons Team For Parking Area To Easy Entry And Exit.**
- **Fully Subjective Exhibition Till Now In India.**
- **Subjective Domes To Cover Different Business Categories.**
- **300+ Stalls From 9 Sq. Mtr. To 108 Sq. Mtr.**
- **Official Timings For Quality Visitors.**
- **One-Way Entry For Every Visitors.**
- **Each And Every Stall Has To Be Visit Concept.**
- **50000+ Visitors.**
- **Exhibitors From Across India & Overseas.**
- **Supported by More Then 10 Different Associations.**
- **Visitors From Across World.**
- **Free Entry Subject To Registration.**
- **80% Visitors Are from B2B Segments & Rest Of 20% Are From B2C+General.**
- **99% Visitors Got What They Want.**
- **Almost 75% Products Are Sold In Exhibition.**
- **FOC basis hydra & forklifts for subjective exhibitors for loading / unloading.**
- **Free And Easy Loading / Unloading & Entry / Exit Process.**
- **75% Exhibitors Get New Area And Horizon For Their Existing Business**
- **95% Exhibitors Get New Suppliers As Well As Vendors.**
- **25+ Subjective And Dedicated Agencies To Fulfill Each & Every Requirements Of Exhibitors As Well As Visitors.**
- **Total Media Coverage From Digital Marketing, Cinema Ad, Hoarding On Prime Locations, TV News Channels, Radio And News Papers To Attract Visitors From Different Locations.**
- **Closing Ceremony Covers Specially Designed Memento For All Exhibitors. Also provided Digital Visiting card with QR code for every exhibitor.**
- **We Achieve 98% Satisfaction Ratio Of Participants And Visitors.**

## Subjective Exhibition Benefits

- ▶ Loading and unloading facility will be provided complimentary by us (Hydra & Forklift Service).
- ▶ You will receive a 20 Ltr. of Water Jug On your stall every Morning.
- ▶ Fascia name, 3 spot lights, 1 – 5 amp. Plug, 1- table, 2-chair, 1-dustbin, carpet flooring.
- ▶ Path-way is 20 ft. wider (Any expo didn't Gave this space.
- ▶ Timing is 10 to 6 pm. Official time for quality visitors. (Last day of Exhibition Timing is 10 to 4pm).
- ▶ Conference space for next level business meetings.
- ▶ Security will be provided with CCTV camera recording for 24 hours a day.
- ▶ On Site H.R. Service Agency available for temporary Staff at Your Stall.
- ▶ Stall Interior Agencies available for Your Stall Decoration.

## Pre Exhibition Benefits

- ▶ Whatsapp marketing in filtered data from our database of 5 million so that, you will get interested visitors as well as genuine buyers.
- ▶ 1 lac invitation card to be distributed in all over India. (50 cards) given to individual participant If you are our Gold or Silver sponsor then your logo will appear in our every promotional things Like our brochure, social media activities, news paper advertisements, TV advertisements, participant directory, website, hoardings, main entry gate and many more.
- ▶ Your LOGO will be printed in our next brochure.

## Post Exhibition Benefits

- ▶ You will receive a list of visitors in soft copy by email who visited your dome in exhibition.
- ▶ Participant directory will help your future customer to find you as we distribute it in every visit of our marketing
- ▶ Your LOGO will be printed in our next brochure.

### GOLD SPONSOR

Complimentary Space Of 54 Square Meters In the Mega Exhibition In A Prominent Location. Recognition As A Gold Sponsor With Corporate Logo With Hyperlink Provided To The Sponsor's Website From Engiexpo. (Website - www.engiexpo.com) Recognition As A Gold Sponsor On Brochure Prepared For The Engiexpo Including Backdrop For Engiexpo Exhibitor's Souvenir, In Over 1 Lakhs Invitations Cards To Be Printed For The Show, etc. 1 Full Page Colour Advertisement In The Engiexpo Exhibitor's Souvenir (Material To Be Supplied By The Sponsor).

### SILVER SPONSOR

Complimentary Space Of 36 Square Meters In the Mega Exhibition In A Prominent Location. Recognition As A Silver Sponsor With Corporate Logo. Recognition As A Silver Sponsor On Brochure Prepared For The Engiexpo Including Backdrop For Engiexpo Exhibitor's Souvenir, In Over 1 Lakhs Invitations Cards To Be Printed For The Show, etc. 1 Half Page Colour Advertisement In The Engiexpo Exhibitor's Souvenir (Material To Be Supplied By The Sponsor).

### PARTNER TAG

Complimentary Space Of 27 Square Meters In the Mega Exhibition In A Prominent Location. Recognition As A Subjective Partner With Corporate Logo. Recognition As A Subjective Partner On Brochure Prepared For The Engiexpo Including Backdrop For Engiexpo etc. 1 Half Page Colour Advertisement In The Engiexpo Exhibitor's Souvenir (Material To Be Supplied By The Sponsor).

## Cost

	STANDARD BOOTH (Per Sq Mtr)	BARE SPACE (Per Sq Mtr)
Indian	14,000/-	13,000/-
Foreign	350\$	325\$
Security Deposite	GST AS APPLICABLE ON ABOVE RATES	
25,000 (Refundable)		

### ADDITIONAL REQUIREMENT COST:

Additional Requirement - Compressor				Power
	3 CFM with 100 Psi (Per Connection)	6 CFM with 100 Psi (Per Connection)	10 CFM with 100 Psi (Per Connection)	3 Phase Power (Per HP)
Indian	12,000/-	16,000/-	20,000/-	2,500/-
Foreign	\$300	\$400	\$500	\$80



Scan here to pay



All Bharat QR / BHIM UPI Apps accepted.



& more

2 WAY ADVERTISING  
TID NO. 0812088



02819 317



PREMIUM SPACE COST : 2 SIDES OPEN 15% EXTRA | 3 SIDES OPEN 25% EXTRA | 4 SIDES OPEN 30% EXTRA

# Our Promotional Activities and Branding

We follow a Marketing Strategy to bringing the Peoples to our Event and Maximising Attending throughout the Event.

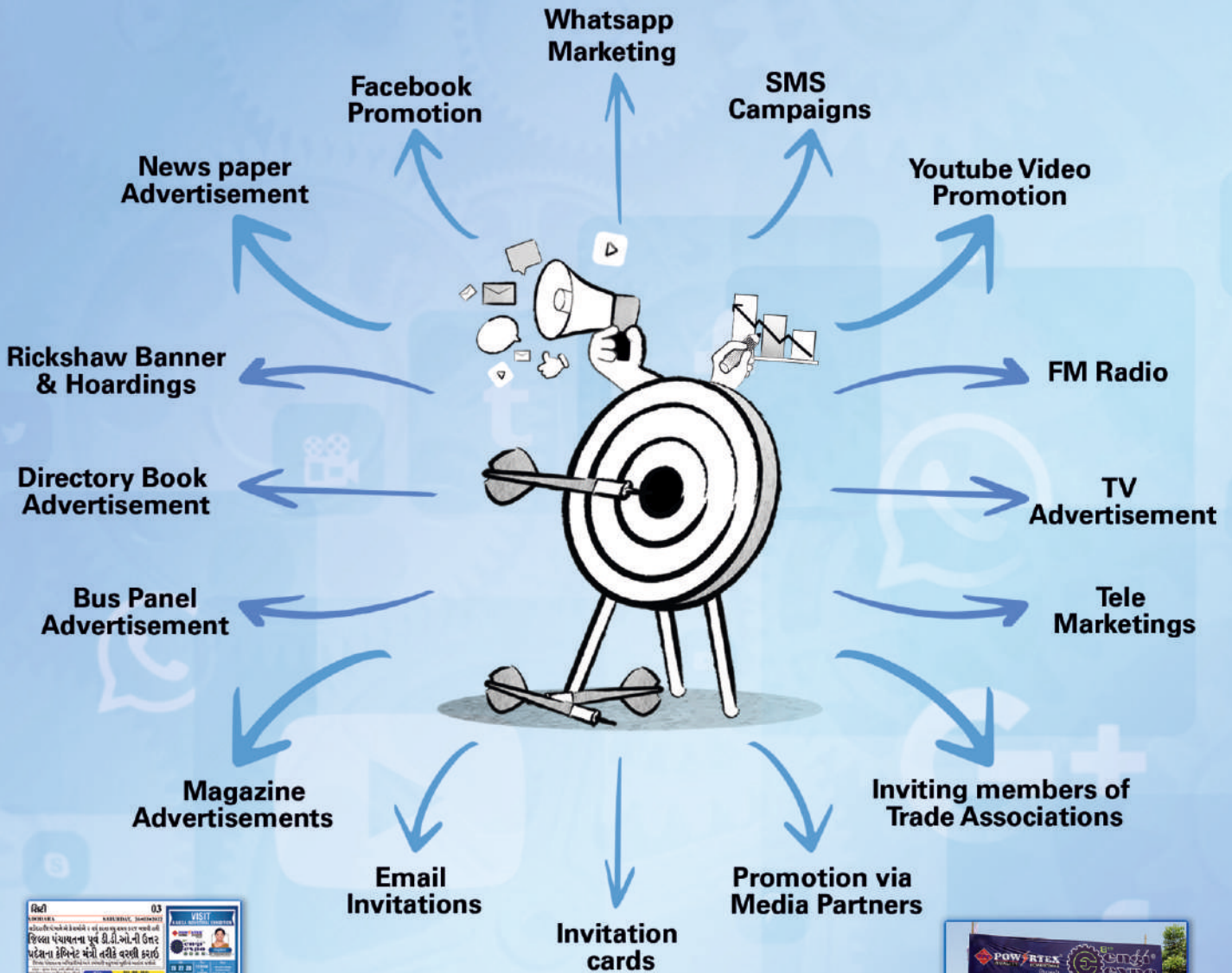

# Stall Sizes

**Stall Back Height : 2.4Mtr.**  
**Stall Front Height : 3Mtr.**  
**Lamination Sheet Width : 1 Mtr.**  
**Table Size :**  
**FRONT : 38" Width X 23" Height**  
**SIDE : 17.5" Width X 23" Height**

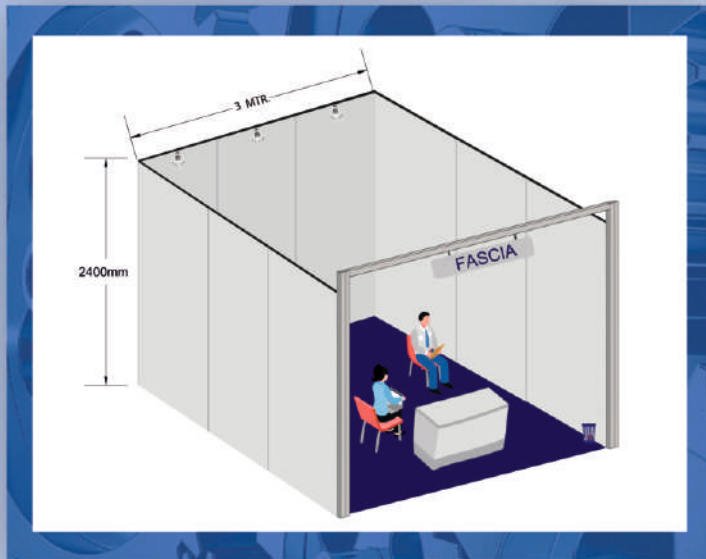

## **3Mtr x 3Mtr (9Sq. Mtr.) Stall**

**1 Nos. Tables, 1 Nos. 5 Amp. Plug Point,**  
**1 Dustbin, 2 Nos. Moulded Chairs,**  
**3 Participant Badges,**  
**3 Spot Lights, 100 Nos. Invitation Cards,**  
**1 20 Ltr. Drinking Water Jug per day.**  
**Name on Fascia (Vinyl), Carpet Flooring,**  
**Laminated Stall.**

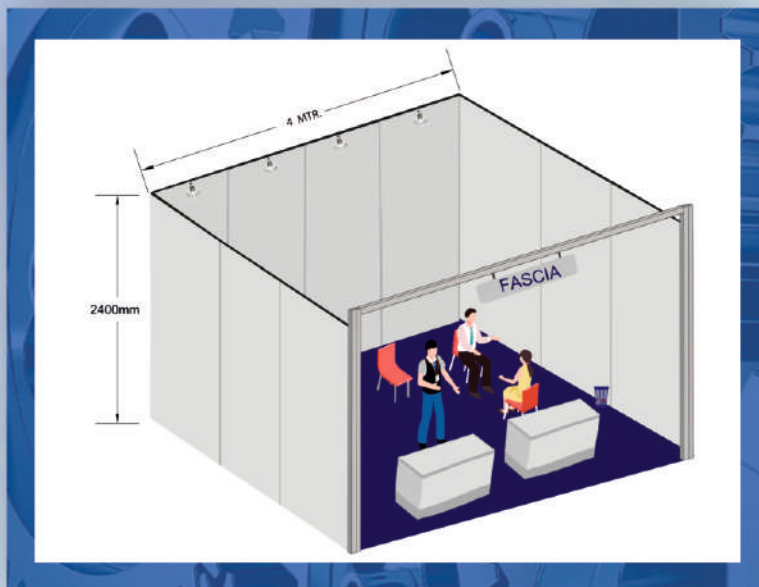

## **4Mtr x 3Mtr (12Sq. Mtr.) Stall**

**2 Nos. Tables, 2 Nos. 5 Amp. Plug Point,**  
**1 Dustbin, 3 Nos. Moulded Chairs,**  
**3 Participant Badges,**  
**4 Spot Lights, 100 Nos. Invitation Cards,**  
**1 20 Ltr. Drinking Water Jug per day.**  
**Name on Fascia (Vinyl), Carpet Flooring,**  
**Laminated Stall.**

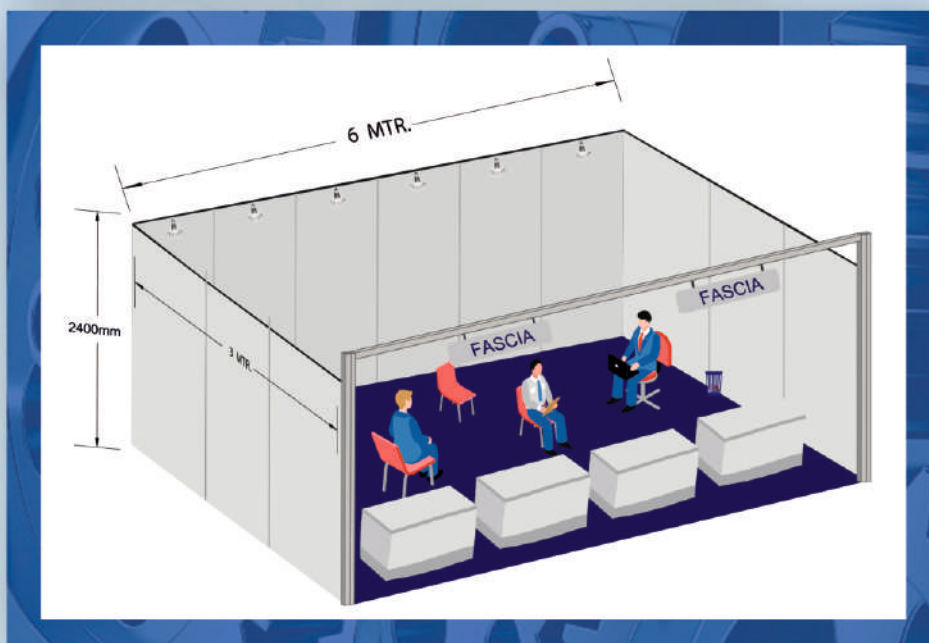

## **6Mtr x 3Mtr (18Sq. Mtr.) Stall**

**4 Nos. Tables, 2 Nos. 5 Amp. Plug Point,**  
**1 Dustbin,**  
**4 Nos. Moulded Chairs,**  
**4 Participant Badges,**  
**6 Spot Lights,**  
**100 Nos. Invitation Cards,**  
**1 20 Ltr. Drinking Water Jug per day.**  
**Name on Fascia (Vinyl), Carpet Flooring,**  
**Laminated Stall.**

### 9Mtr x 3Mtr (27Sq. Mtr.) Stall

5 Nos. Tables,  
2 Nos. 5 Amp. Plug Point,  
1 Dustbin, 6 Nos. Moulded Chairs,  
5 Participant Badges,  
9 Spot Lights,  
100 Nos. Invitation Cards,  
120 Ltr. Drinking Water Jug per day.  
Name on Fascia (Vinyl),  
Carpet Flooring, Laminated Stall.



### FOR AHMEDABAD : 9Mtr x 6Mtr (54Sq. Mtr.) Stall

### FOR RAJKOT, VADODARA & SURAT : 6Mtr x 6Mtr (36Sq. Mtr.) Stall

6 Nos. Tables, 2 Nos. 5 Amp. Plug Point, 1 Dustbin, 8 Nos. Moulded Chairs, 6 Participant Badges,  
9 Spot Lights, 100 Nos. Invitation Cards, 120 Ltr. Drinking Water Jug per day.  
Name on Fascia (Vinyl), Carpet Flooring, Laminated Stall.

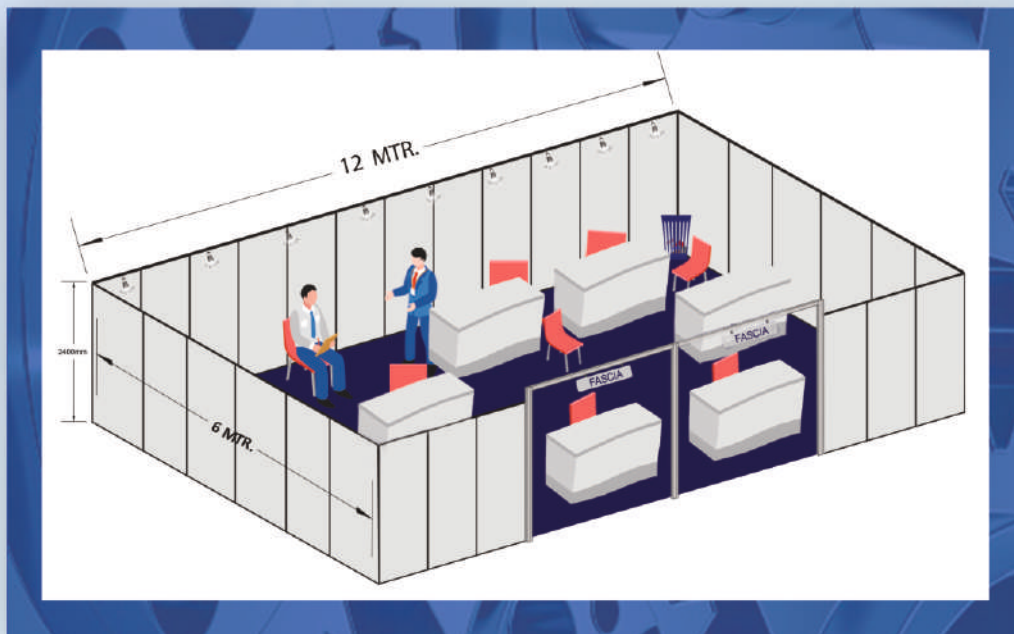

### FOR AHMEDABAD 12Mtr x 9Mtr (108Sq. Mtr.) Stall

10 Nos. Tables,  
4 Nos. 5 Amp. Plug Point,  
1 Dustbin,  
10 Nos. Moulded Chairs,  
8 Participant Badges,  
12 Spot Lights,  
100 Nos. Invitation Cards,  
120 Ltr. Drinking Water Jug  
per day.  
Name on Fascia (Vinyl),  
Carpet Flooring,  
Laminated Stall.

### FOR SURAT, RAJKOT & VADODARA : 12Mtr x 6Mtr (72Sq. Mtr.) Stall

6 Nos. Tables, 2 Nos. 5 Amp. Plug Point, 1 Dustbin, 8 Nos. Moulded Chairs, 6 Participant Badges, 9 Spot Lights,  
100 Nos. Invitation Cards, 120 Ltr. Drinking Water Jug per day. Name on Fascia (Vinyl), Carpet Flooring,  
Laminated Stall.

NOTE : NO TABLE, CHAIR, SPOT LIGHTS & CARPET WILL BE PROVIDED FOR BARE SPACE

# Rajkot - 17, 18, 19, 20 December 2023

## MATERIAL HANDLING CONSTRUCTION/HARDWARE PRODUCTS

# DOME 1

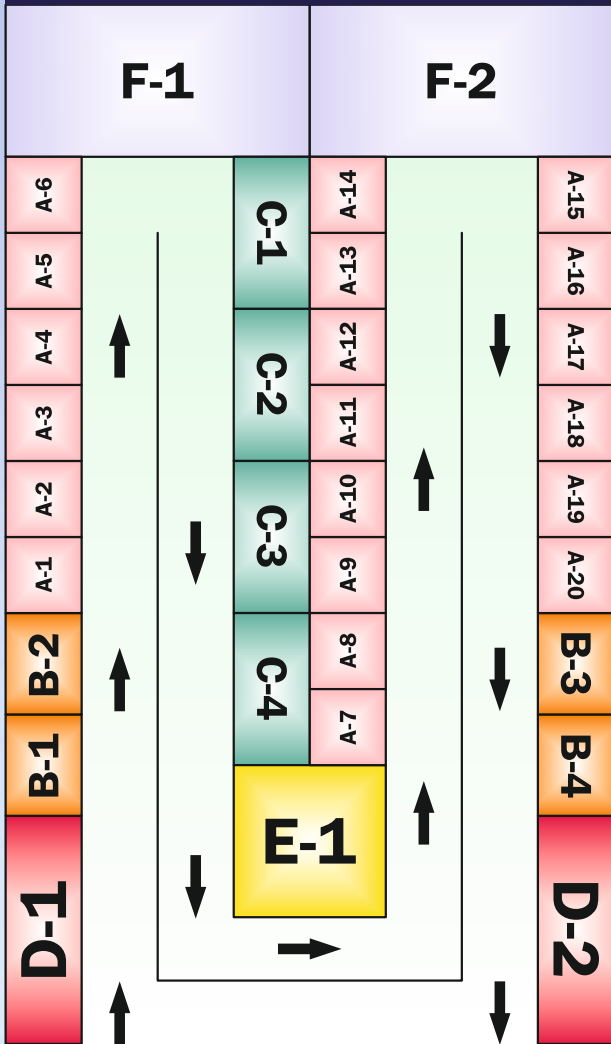

### Category

- Crane/Hoist/Chain Pulley Block
- Material Handling Conveyor
- Conveyor System
- Chain & Sprocket
- Pulley / Coupling
- Elevator
- Lifting Material / Belt
- Hydraulic Equipments
- Industrial Trolleys
- Construction / Earthmoving Equipments
- Stacker / Hydraulic Pallet Stacker
- Castor Wheel / Trolley Wheel
- Wire Rope / Slings
- Rolling Shutters
- Entrance Automation System
- Multilevel Parking System
- Moving Walkways
- Scaffolding
- Builders (Industrial/Commercial)
- Agitator
- NC Servo Feeders
- Teflon / Fluon / PTFE / UHMW
- Valve / Cock
- Drilling & Boring Equipments
- Pipe / Tube (Rigid Flexible)
- Storage Tank / Cleaning Equipments
- Gear Box / Reduction Gear
- PEB Structure
- Roofing Material
- Pest Control Service

## MACHINE TOOL AUTOMATION/FASTENERS

# DOME 2

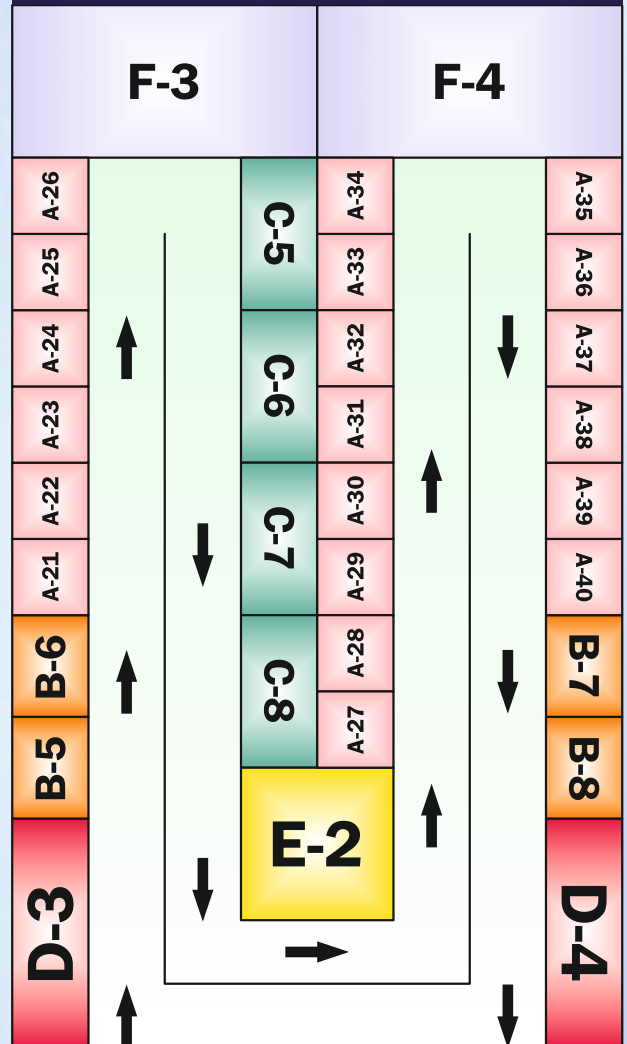

### Category

- CNC / VMC / HMC Mfrs.
- Workshop Machinery / Parts
- Processing Machine / Plant / Equipment
- Robotic / Automation
- Hydraulic - Shearing / Bending Presses
- Bailing Press Machines
- Rolling Mill Machines
- Utensil Machines
- Paper Mill Machines
- Magnet / Magnetic Equipments
- Rubber Belt / V- Belt
- Bearing • Hose / Tubing
- Boiler / Boiler Parts
- Tools & Industrial Hardware
- Bolt/Nut/Fastener • Spring Mfrs.
- Plastic Machinery
- Printing Machinery
- Packaging Machinery
- Powder Coating Eqpt. / Material
- Electroplating / Galvanising / Anodising
- Rod Bending / Pipe Bending Machine
- Metal Cutting Hacksaw
- CAD / CAM Technologies
- Nail Making Machine
- Marking / Engraving Machine
- Heat Treatment Eqpt. / Furnace
- Lubricating Oil / Grease
- Paint
- Testing & Measuring Eqpt.
- Calibration Equipment
- Textile Machine / Parts
- Pneumatic System
- Pharmaceutical Machineries
- Pump (Vacuum/ Chemical Process / Centrifuge)
- Mechanical Shaft
- Process Control Automation
- Instrument Instrumentation
- Scientific Instruments & Glassware



# Rajkot - 17, 18, 19, 20 December 2023

## MACHINE TOOL AUTOMATION/FASTENERS

# DOME 3

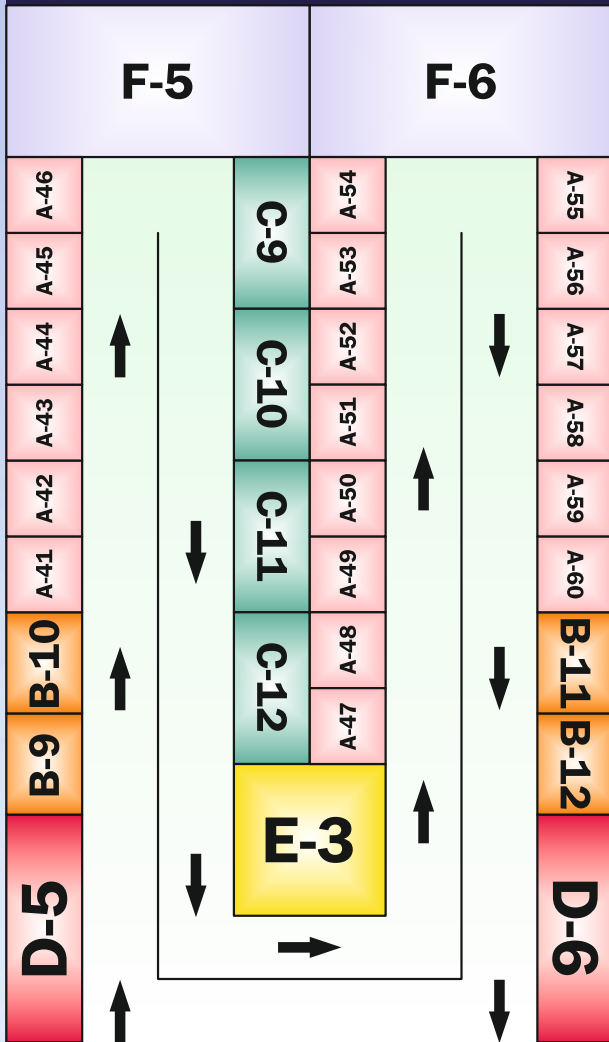

### Category

- CNC / VMC / HMC Mfrs.
- Workshop Machinery / Parts
- Processing Machine / Plant / Equipment
- Robotic / Automation
- Hydraulic - Shearing / Bending Presses
- Bailing Press Machines
- Rolling Mill Machines
- Utensil Machines
- Paper Mill Machines
- Magnet / Magnetic Equipments
- Rubber Belt / V- Belt
- Bearing • Hose / Tubing
- Boiler / Boiler Parts
- Tools & Industrial Hardware
- Bolt/Nut/Fastener • Spring Mfrs.
- Plastic Machinery
- Printing Machinery
- Packaging Machinery
- Powder Coating Eqpt. / Material
- Electroplating / Galvanising / Anodising
- Rod Bending / Pipe Bending Machine
- Metal Cutting Hacksaw
- CAD / CAM Technologies
- Nail Making Machine
- Marking / Engraving Machine
- Heat Treatment Eqpt. / Furnace
- Lubricating Oil / Grease
- Paint
- Testing & Measuring Eqpt.
- Calibration Equipment
- Textile Machine / Parts
- Pneumatic System
- Pharmaceutical Machineries
- Pump (Vacuum/ Chemical Process / Centrifuge)
- Mechanical Shaft
- Process Control Automation
- Instrument Instrumentation
- Scientific Instruments & Glassware

## WELDING/CUTTING SAFETY/POWER TOOLS

# DOME 4

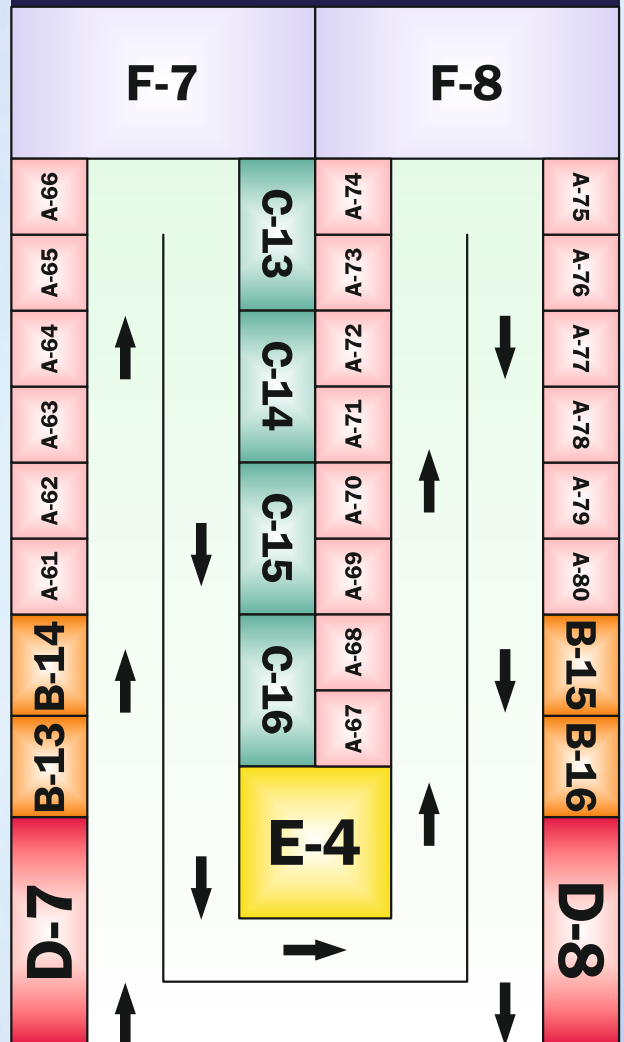

### Category

- Welding Machine –
- Arc Welders / MIG Welders / TIG Welders
- Welding Rods Electrodes
- Welding Wire / Cable
- Welding Helmet
- Inverter Welding Machine
- Robotic Welding Machine
- CNC Plasma Cutting Machine
- Welding /Cutting Automation
- Automation Welding System
- CNC Profile Cutting Machine
- CNC Plasma Pipe Cutting Machine
- CNC Laser Cutting Machine
- Abrasive Cutoff Machine
- Coated Abrasives
- Bonded Abrasives
- Polishing Abrasives
- Abrasive Belts / Rolls / Discs /Paper
- Safety Equipments
- Welding Safety Equipments
- Road Safety Equipments
- Industrial Safety Equipments
- Fire Fighting Industrial Safety Eqpt.
- Fire Safety Equipments
- Power Tools
- Hand Tools
- Industrial Power Tools
- Battery Power Tools
- Cordless Power Tools
- Pneumatic Power Tools

# Rajkot - 17, 18, 19, 20 December 2023

## WELDING/CUTTING SAFETY/POWER TOOLS

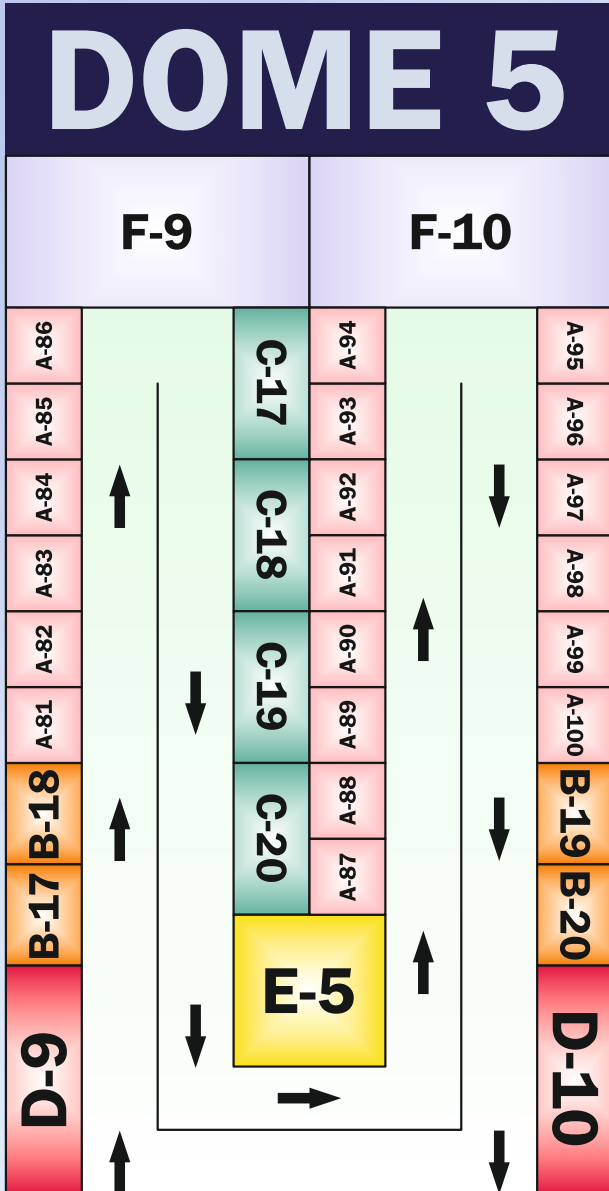

### Category

- CNC / VMC / HMC Mfrs.
- Workshop Machinery / Parts
- Processing Machine / Plant / Equipment
- Robotic / Automation
- Hydraulic - Shearing / Bending Presses
- Bailing Press Machines
- Rolling Mill Machines
- Utensil Machines
- Paper Mill Machines
- Magnet / Magnetic Equipments
- Rubber Belt / V- Belt
- Bearing • Hose / Tubing
- Boiler / Boiler Parts
- Tools & Industrial Hardware
- Bolt/Nut/Fastener • Spring Mfrs.
- Plastic Machinery
- Printing Machinery
- Packaging Machinery
- Powder Coating Eqpt. / Material
- Electroplating / Galvanising / Anodising
- Rod Bending / Pipe Bending Machine
- Metal Cutting Hacksaw
- CAD / CAM Technologies
- Nail Making Machine
- Marking / Engraving Machine
- Heat Treatment Eqpt. / Furnace
- Lubricating Oil / Grease
- Paint
- Testing & Measuring Eqpt.
- Calibration Equipment
- Textile Machine / Parts
- Pneumatic System
- Pharmaceutical Machineries
- Pump (Vacuum/ Chemical Process / Centrifuge)
- Mechanical Shaft
- Process Control Automation
- Instrument Instrumentation
- Scientific Instruments & Glassware

## BUSINESS OPPORTUNITY/ I.T. / FINANCE / TOURISM

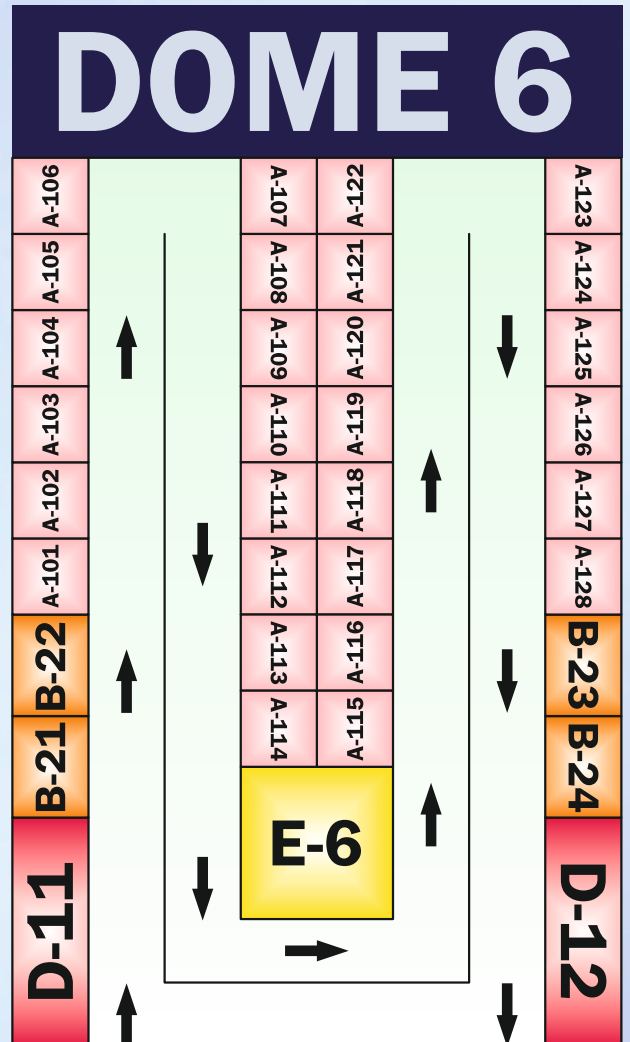

### Category

- I.T. Consulting & Project Management
- I.T. Project Consultancy
- Project Management
- Software Project Management Service
- Turnkey Project Consulting Service
- Software Developers / Management
- Computer Hardware
- Computer Networking
- Website Developer / Designer
- Google Promotion / SEO Consultant
- Social Media Marketing
- Finance Consultant
- Finance Companies
- Advertising Agency / Consultant
- Franchise
- Bank
- Corporate
- Tour Operator
- Visa Consultant
- Tourism Management

# Rajkot - 17, 18, 19, 20 December 2023

## ELECTRICAL/ELECTRONICS SOLAR/WEIGHING SCALE

### DOME 7

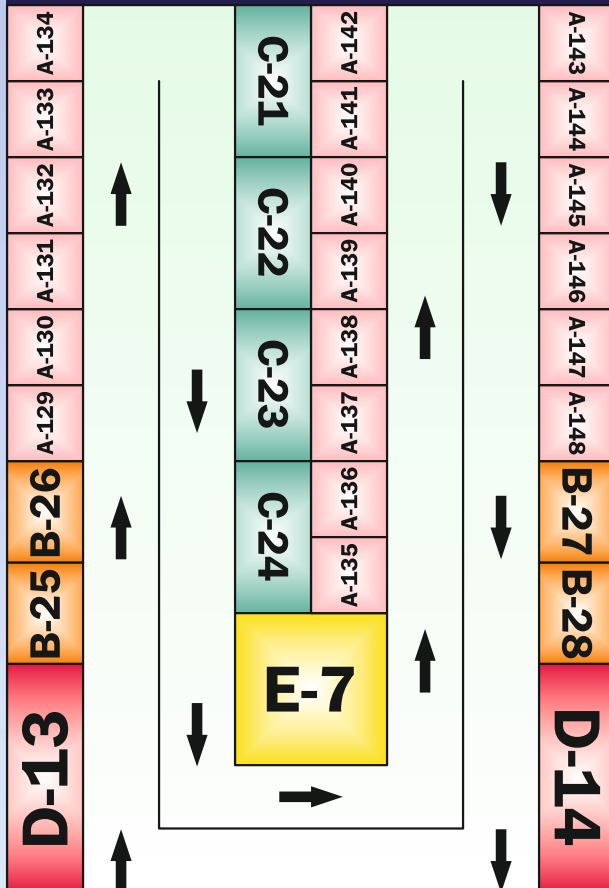

### Category

- Electric Motor
- Submersible Pump
- Lighting Pole
- Servo Stabilizer
- Transformer / Parts
- Control Panel / Accessories
- Solar Energy Equipment
- Power Plant Equipment
- Electrical Instrument
- Humidification / Ventilation
- Blower & Blower System
- Burner
- UPS / Inverter / Stabilizer
- Earthing Material
- LED Lights
- Electrical Heating Element/ Thermostat
- Cable/Cable Management System
- Insulating Material
- Switchgear
- Electrical Stamping & Lamination
- Air Cooler
- Air Conditioner
- Electric Switch
- CCTV Camera
- Electronic Weighing Scale Mfrs./importers
- Weighing Scale Body Mfrs.
- Load Cell Mfrs./importers
- Weighbridge Mfrs.
- Weighing Accessories
- Batteries • Stickers / Label Mfrs.
- Currency Counting Machines
- Water Purifier / Filtration Plant

## WELDING/CUTTING POWER TOOLS/SAFETY

### DOME 8

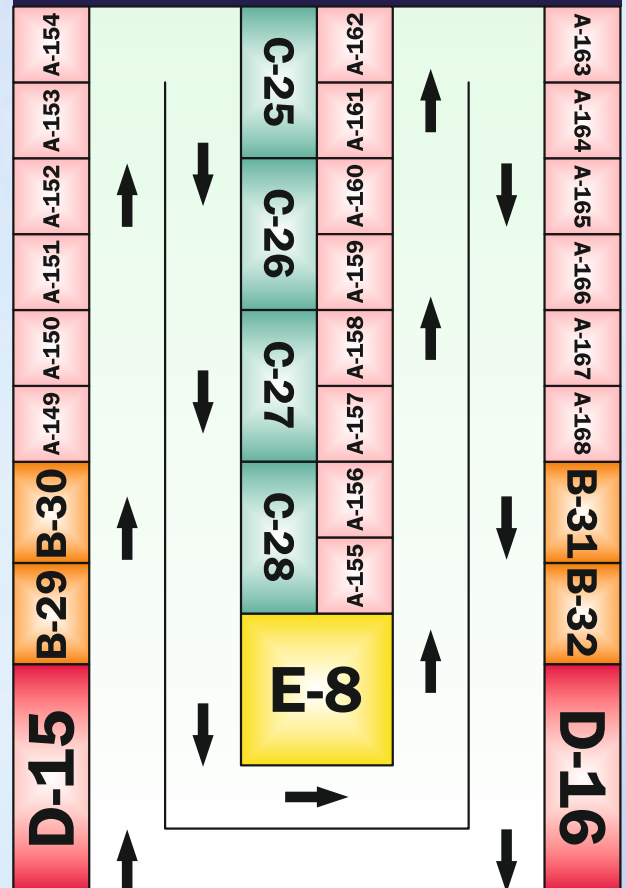

### Category

- Welding Machine –
- Arc Welders / MIG Welders / TIG Welders
- Welding Rods Electrodes
- Welding Wire / Cable
- Welding Helmet
- Inverter Welding Machine
- Robotic Welding Machine
- CNC Plasma Cutting Machine
- Welding /Cutting Automation
- Automation Welding System
- CNC Profile Cutting Machine
- CNC Plasma Pipe Cutting Machine
- CNC Laser Cutting Machine
- Abrasive Cutoff Machine
- Coated Abrasives
- Bonded Abrasives
- Polishing Abrasives
- Abrasive Belts / Rolls / Discs /Paper
- Safety Equipments
- Welding Safety Equipments
- Road Safety Equipments
- Industrial Safety Equipments
- Fire Fighting Industrial Safety Eqpt.
- Fire Safety Equipments
- Power Tools
- Hand Tools
- Industrial Power Tools
- Battery Power Tools
- Cordless Power Tools
- Pneumatic Power Tools

# Rajkot - 17, 18, 19, 20 December 2023

## MACHINE TOOL AUTOMATION/FASTENERS

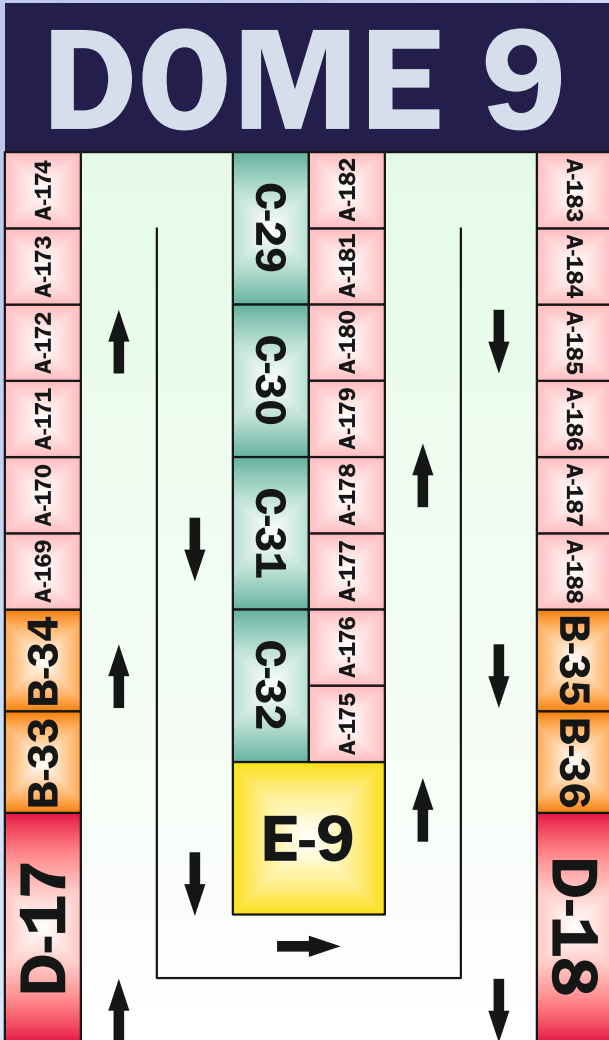

## MACHINE TOOL AUTOMATION/FASTENERS

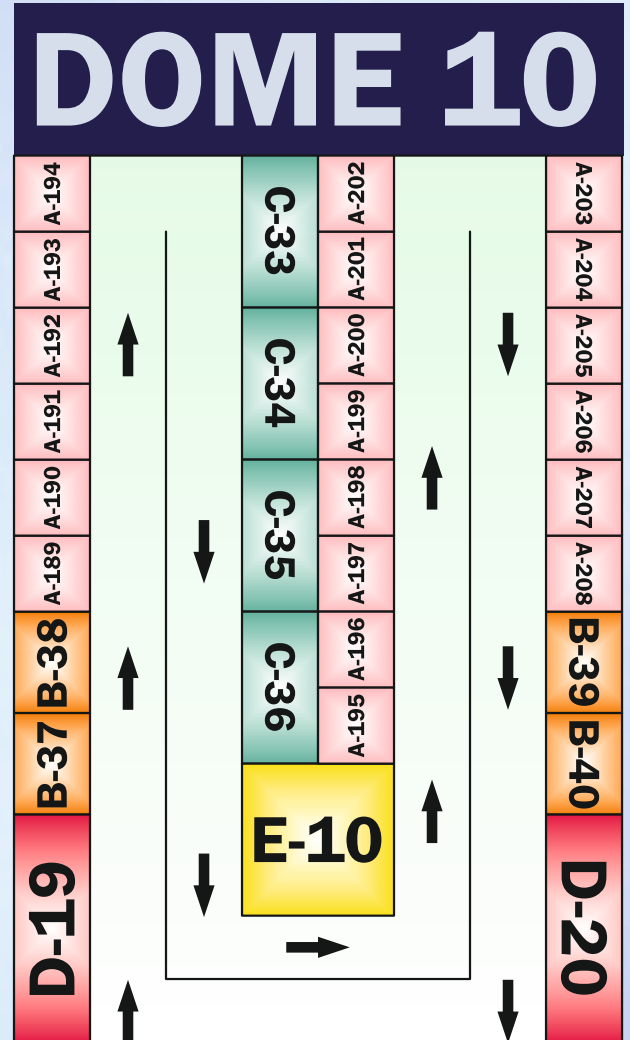

## Category

- CNC / VMC / HMC Mfrs.
- Workshop Machinery / Parts
- Processing Machine / Plant / Equipment
- Robotic / Automation
- Hydraulic - Shearing / Bending Presses
- Bailing Press Machines
- Rolling Mill Machines
- Utensil Machines
- Paper Mill Machines
- Magnet / Magnetic Equipments
- Rubber Belt / V- Belt
- Bearing • Hose / Tubing
- Boiler / Boiler Parts
- Tools & Industrial Hardware
- Bolt/Nut/Fastener • Spring Mfrs.
- Plastic Machinery
- Printing Machinery
- Packaging Machinery
- Powder Coating Eqpt. / Material
- Electroplating / Galvanising / Anodising
- Rod Bending / Pipe Bending Machine
- Metal Cutting Hacksaw
- CAD / CAM Technologies
- Nail Making Machine
- Marking / Engraving Machine
- Heat Treatment Eqpt. / Furnace
- Lubricating Oil / Grease
- Paint
- Testing & Measuring Eqpt.
- Calibration Equipment
- Textile Machine / Parts
- Pneumatic System
- Pharmaceutical Machineries
- Pump (Vacuum/ Chemical Process / Centrifuge)
- Mechanical Shaft
- Process Control Automation
- Instrument Instrumentation
- Scientific Instruments & Glassware

**A**  
3M X 3M (9SQ.MTR)

**B**  
4M X 3M (12SQ.MTR)

**C**  
6M X 3M (18SQ.MTR)

**D**  
9M X 3M (27SQ.MTR)

**E**  
6M X 6M (36SQ.MTR)

**F**  
12M X 6M (72SQ.MTR)

# Rajkot - 17, 18, 19, 20 December 2023

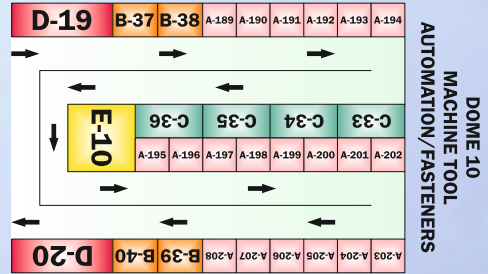
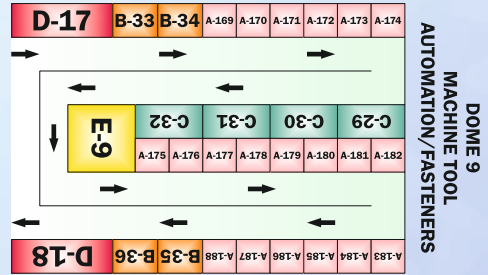
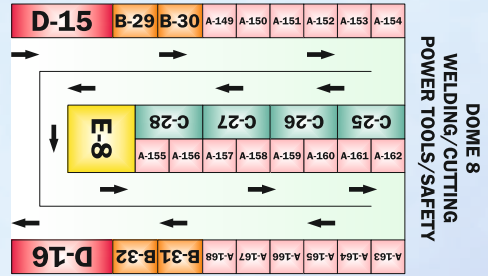
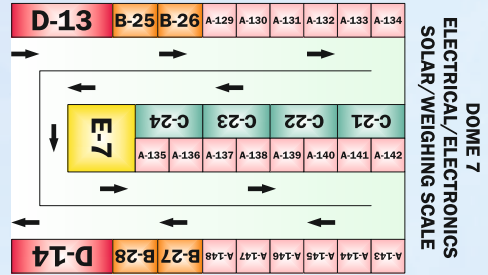
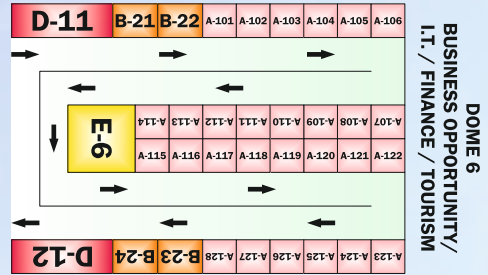
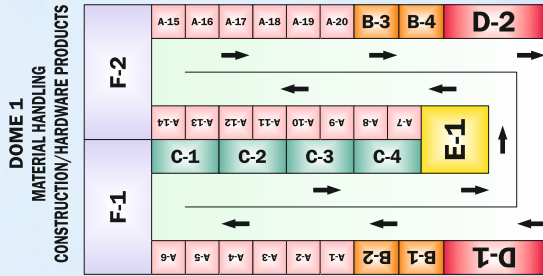
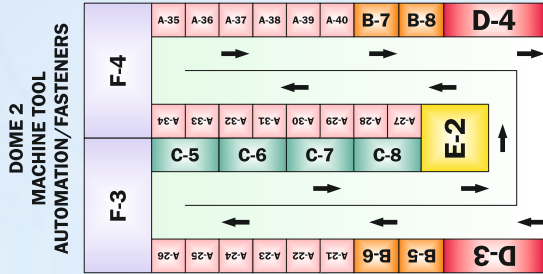
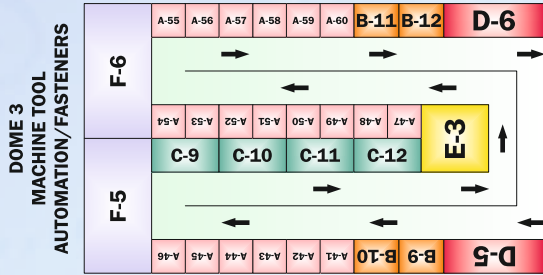
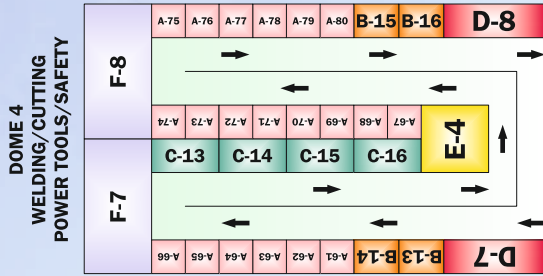
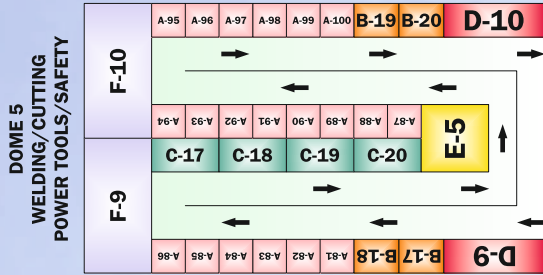
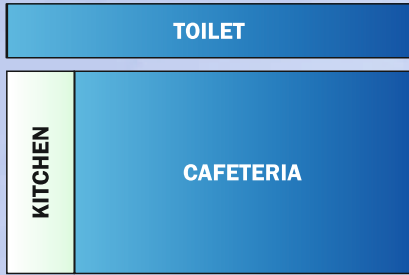

MAIN GATE

9TH AHMEDABAD  
17, 18, 19 December 2022

10TH SURAT  
18, 19, 20 February 2023

11TH RAJKOT  
17, 18, 19, 20, December 2023

12TH VADODARA  
17, 18, 19, February 2024

# Our Valuable Clients



9TH AHMEDABAD  
17, 18, 19 December 2022

10TH SURAT  
18, 19, 20 February 2023

11TH RAJKOT  
17, 18, 19, 20, December 2023

12TH VADODARA  
17, 18, 19, February 2024

# Our Valuable Clients

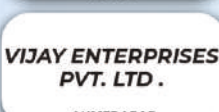
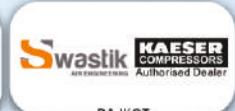

9TH AHMEDABAD  
17, 18, 19 December 2022

10TH SURAT  
18, 19, 20 February 2023

11TH RAJKOT  
17, 18, 19, 20, December 2023

12TH VADODARA  
17, 18, 19, February 2024

# Our Valuable Clients





9TH AHMEDABAD  
17, 18, 19 December 2022

10TH SURAT  
18, 19, 20 February 2023

11TH RAJKOT  
17, 18, 19, 20, December 2023

12TH VADODARA  
17, 18, 19, February 2024

# Our Valuable Clients

 <b>CLIF</b> CLIF TOOLS PVT. LTD. MUMBAI	 <b>VIJAYRAJ ENGINEERS</b> AHMEDABAD	 Pranav Anodizer Pvt. Ltd. One stop solution for Aluminium Coating VADODARA	 SHREE SAI SCIENTIFIC VADODARA	 SONU TRADING VADODARA	 PAPS PRIME RANGE PUMPING SYSTEMS PVT. LTD. VADODARA
 Shree Ambe ENGINEERING WORKS AHMEDABAD	 UNIFORM WORLD WIDE VADODARA	 ASHAPURA POLYMERS VADODARA	 global marketing VADODARA	 MIHIR ENGINEERING ANAND	 ftech VADODARA
 ADSON ENGINEERING CORPORATION AHMEDABAD	 BVM INDUSTRIES VADODARA	 Technoseal ENGINEERING VADODARA	 PRAMOD ENTERPRISE VADODARA	 Reckers Automation India Pvt Ltd HARYANA	 Empire Industry of Services AN ISO 9001:2015 CERTIFIED COMPANY VADODARA
 VARIATIONAL Technologies Pvt. Ltd. VADODARA	 YOGESHWAR POWER TOOLS VADODARA	 JAI ASHAPURA HYDRAULICS VALSAD	 MAMTA ENTERPRISE VADODARA	 RUTHVI CORPORATION VADODARA	 Genesis Brixton Built to make you better VADODARA
 KABIR INSTRUMENTS & TECHNOLOGY VADODARA	 KEVAL SAFETY MALL VADODARA	 EMTECH SALES & SERVICE VADODARA	 TAE ASHAPURA VADODARA	 Paraa RUBBER VADODARA	 SPECTOART CORPORATION VADODARA
 MAA TRADING CO. VADODARA	 SKY RIF COOLER AHMEDABAD	 DVP INDIA VADODARA	 ANINA TOOLS & ELECTRICALS VADODARA	 VISHANT TOOLS VADODARA	 SHREE MARKETING VADODARA
 H-MAK Pvt. Ltd. VADODARA	 Vedee Associates AHMEDABAD	 UMA ELECTRIC PARTS VADODARA	 HV ENGINEERING VADODARA	 Deepdeal ELECTRICALS PVT. LTD. VADODARA	 Jainflex CABLES PVT. LTD. ANISO9001 2008 COMPANY AHMEDABAD
 Perfect Electro Control VADODARA	 ADCAB Adding Power to Your Life Atlas Cables Pvt. Ltd. KUTCH	 INDIAN POWER TRANS VADODARA	 ELITE TRANSFORMERS INDUSTRIES VADODARA	 BCS BHAVANI CONTROL SYSTEM VADODARA	 TECHNOPHILE AUTOMATION PVT. LTD. VADODARA
 TALSANIA ENGINEERING WORKS AHMEDABAD	 TRANS POWER VADODARA	 INNOVATIVE THE PROFESSIONAL ENDOGENE MANUFACTURER VADODARA	 SHREEN ELECTRO POWER PVT. LTD. VADODARA	 MARUTI TECHNOLOGIES VADODARA	 Prakash Electrical Company VADODARA
 ACCURATE CUTTING SERVICES VADODARA	 Fasto Your Adhesive Expert AHMEDABAD	 NEW INDIA THE GOLD MFT SURAT	 ANS Innovate ADVANCED POWER SOURCES LIMITED VALSAD	 Shree Krishna Transformers AHMEDABAD	 TRANSASIA PETROCHEM PVT LTD VADODARA
 GOLDCOIN GROUP GOLDCOIN MULTIPACK PVT.LTD. AHMEDABAD	 MACHNO INDIA providing solutions in Industrial Automation AHMEDABAD	 3-STAR LABELS SURAT	 innotech automation VADODARA	 BMLW SIGNS Barode Metal Label Works VADODARA	 MICROFINE PRODUCTS VADODARA
 DEVAJ ENGINEERING AHMEDABAD	 CTC IMPEX (INDIA) PVT. LTD. MUMBAI	 COMPETENCE-CNC SURAT	 blacksmith AHMEDABAD	 ADVA-TECH Engineers AHMEDABAD	 KRISHNA STEEL TRADERS VADODARA
 JALARAM ENTERPRISE AHMEDABAD	 JKT AHMEDABAD	 Payal Engineering AHMEDABAD	 Chamunda EQUIPMENTS AHMEDABAD	 AIR MARSHAL COMPRESSORS Gajjar Compressor Pvt. Ltd. AHMEDABAD	 Prism Test & Measure Pvt Ltd. AHMEDABAD

9TH AHMEDABAD  
17, 18, 19 December 2022

10TH SURAT  
18, 19, 20 February 2023

11TH RAJKOT  
17, 18, 19, 20, December 2023

12TH VADODARA  
17, 18, 19, February 2024

# Our Valuable Clients

 EMPOWER Makes Business Simplified AHMEDABAD	 GANSHI UNIFORM PVT. LTD. Only Corporate Uniform AHMEDABAD	 HAMRAHI WIREMESH AHMEDABAD	 INFORCE ENGINEERING AHMEDABAD	 INTERNATIONAL INDUSTRIAL SPRINGS Shaping Springs For Life THANE	 Khodiyar Industries Specialty of Cores MEHSANA
 Shah Expansion Joints (Bellows) Manufacturers VADODARA	 Reliable ENGINEERS AHMEDABAD	 PARAG Electrodes Agencies Pvt. Ltd. We value your trust AHMEDABAD	 TUCKER POWER TOOLS NIRALI OVERSEAS MUMBAI	 MSPL Meddo Safehawk Pvt. Ltd. DELHI	 Marvel Air Flow AHMEDABAD
 Shiv Shakti INDUSTRIES AHMEDABAD	 SMART TECHNOPACK AHMEDABAD	 SUNRISE GROUP GANDHINAGAR	 Ujjawal Enterprise with 25 years of Industrial Experience AHMEDABAD	 VENUS LASER TECHNOLOGY AHMEDABAD	 VITAL ELECTROCOMP VADODARA
 Performer AE ABRASIVES EDGE PVT LTD DELHI	 Ankit AIR COMPRESSOR AHMEDABAD	 BDS MASCHINEN BDS MACHINES PVT LTD AURANGABAD	 Charmi ENTERPRISE AHMEDABAD	 G. I. Lokhandwala Clear Solutions for Manual Tooling & Lifting Equipment AHMEDABAD	 JD CONTROLS AHMEDABAD
 PARAMOUNT FASTENER AHMEDABAD	 SHREE LAXMI TRADING AHMEDABAD	 BE Balaji Enterprises Auth. Dealer Makita AHMEDABAD	 Camron CAMRON INTERNATIONAL DELHI	 DE NEERS TOOLS LLP. Best Ever Tools DELHI	 ENCORE COOLING SYSTEMS VADODARA
 IDEAL POWER TOOLS IDEAL INTERNATIONAL POWER TOOLS PVT LTD MUMBAI	 K.P. SALES AHMEDABAD	 OZAR TOKU MEHTA TEXTILE TRADING CO. AHMEDABAD	 GROZ Tools to Trust NAVKAR ENTERPRISE AHMEDABAD	 ALPHA Professional Power Tools DELHI	 P/M TOOLS & ABRASIVES UTTAR PRADESH
 QH Qutbi Hardware AHMEDABAD	 S.P. KOTHARI & CO. AHMEDABAD	 SHREEJI INDUSTRIES AHMEDABAD	 ULTRAFAST SHRI SHYAMJI TOOLS PVT LTD DELHI	 HIKOKI HIGH PERFORMANCE POWER TOOLS MAHAVIR INTERNATIONAL TOOLS AHMEDABAD	 TOOLS CENTRE AHMEDABAD
 VIRAL INDUSTRIES AHMEDABAD	 WEST INDIA WINDS NEW SAILING SERVICE LLP MAHARASHTRA	 VIRGO SOLUTIONS INDIA LLP SECUNDERABAD	 ACRO ENTERPRISE HARAYAN	 AMBICA HONE ENGINEERS AHMEDABAD	 AMIRAJ ENTERPRISE AHMEDABAD
 anubhuti power system AHMEDABAD	 Arihant Beiting Pvt. Ltd. SURAT	 BANSI IMPEX SURAT	 Bluesky Hose Manufacturing India Pvt.Ltd. TAMILNADU	 CARE Process Instrument PRESSURE - TEMP - FLOW - LEVEL - SENSING - HAZ AN ISO 9001 : 2008 Certified Co. AHMEDABAD	 CHAKSHU ENGINEERING Since 1987 AHMEDABAD
 ELMRAD Corporation A Force Behind the Growth VADODARA	 EXFIN WHERE GROWTH MATTERS AHMEDABAD	 GAYLORD ENTERPRISE AHMEDABAD	 HANKAY HYDRAAULIC AHMEDABAD	 BONNA-FLEX HASMUKHLAL & BROTHERS RAJKOT	 iPan Machineries GROUP OF COMPANIES (INDIA) Pvt.Ltd. AHMEDABAD
 IDEAL TRANSMISSION CO. AHMEDABAD	 INDUSTRIAL TRADING CENTER SURAT	 JAYCO BEARING HOUSINGS JAYCO GROUP OF INDUSTRIES AHMEDABAD	 J.K. VALVE & CO. AHMEDABAD	 BUSHKINS LABH ENGINEERING AHMEDABAD	 MAHESH FABRICATORS SINCE 2002 AN ISO 9001:2015 Certified Company AHMEDABAD
 MECON TECHNOLOGY AHMEDABAD	 METRO MACHINE TOOLS AHMEDABAD	 MULTICUT MACHINE TOOLS SINCE : 1994 VADODARA	 nu-tech Engineers SUREDRANAGAR	 PRECISE ALLOYS PVT. LTD. MAHARASHTRA	 R B ENTERPRISE AHMEDABAD
 HI-ROOF COLOR COATED ROOF & WALL SHEETS AHMEDABAD	 Amrut ELECTRONICS AHMEDABAD	 DGS AUTOMATION TECHNOLOGIES PVT. LTD. VADODARA	 SHRADDHA FILTER TECHNOLOGY AN ISO 9001:2008 CERTIFIED COMPANY AHMEDABAD	 FIRE TECH ENGINEERS AHMEDABAD	 RAVI ENTERPRISE MFG. PANEL BOARD ACCESSORIES AHMEDABAD

9TH AHMEDABAD  
17, 18, 19 December 2022

10TH SURAT  
18, 19, 20 February 2023

11TH RAJKOT  
17, 18, 19, 20, December 2023

12TH VADODARA  
17, 18, 19, February 2024

## Our Valuable Clients

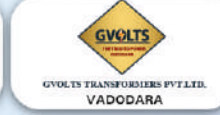
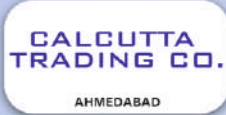

9TH AHMEDABAD  
17, 18, 19 December 2022

10TH SURAT  
18, 19, 20 February 2023

11TH RAJKOT  
17, 18, 19, 20, December 2023

12TH VADODARA  
17, 18, 19, February 2024

## Our Testimonials

**MANUFACTURER,  
EXPORTER &  
SUPPLIER OF  
INDUSTRIAL AIR  
COMPRESSORS**



SUBSCRIBE NOW

02:00/03:00

“ WE ARE VERY SURE THAT ENGIEXPO IS A RIGHT PLATFORM FOR US TO INCREASE OUR VISIBILITY FOR ALL OUR PRODUCTS NATIONALLY AND INTERNATIONALLY. ”

**MANUFACTURERS  
& SUPPLIERS OF  
SWITCHGEARS  
ELECTRONIC  
FASTENERS**



SUBSCRIBE NOW

02:00/03:00

“ ENGIEXPO IS A VERY GOOD PLATFORM WE'RE DEALING WITH THAT PLATFORM SINCE LAST 4 YEARS. IT'S AWESOME PLATFORM SO EVERYONE PLEASE JOIN THIS PLATFORM TO EXPLORE YOUR SELF & YOUR COMPANY. ”

**MANUFACTURER  
AND  
EXPORTER OF  
CAD &  
CAM SYSTEMS**



SUBSCRIBE NOW

02:00/03:00

“ ENGIEXPO IS ALSO ONE OF THE GROWING EXHIBITION IN ENGINEERING INDUSTRIES THEY HAVE DONE FEW EXHIBITIONS BEFORE & NOW ALSO UPCOMING EXHIBITION IN RAJKOT & BARODA. ”

**ALL TYPES  
OF METAL  
FURNITURE  
PRODUCTS  
MANUFACTURERS**



SUBSCRIBE NOW

02:00/03:00

“ LAST YEAR WE GET VERY NICE EXPERIENCE WITH ENGIEXPO & GET MANY CUSTOMER & MANY SOURCES FROM ENGIEXPO, SO WE'RE LOOKING FORWARD TO HAVE MORE CUSTOMERS & MORE VISIBILITY FROM ENGIEXPO. ”

**MANUFACTURER  
OF CNC  
LASER  
CUTTING  
MACHINE**

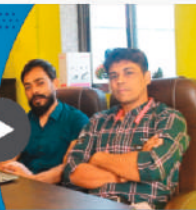

SUBSCRIBE NOW

02:00/03:00

“ WE GOT BEST EXPERIENCE WITH ENGIEXPO & CONNECTED FROM LAST 5 YEARS WITH ENGIEXPO & WE GOT MANY CUSTOMERS FROM THEIR. ”

**Laser Marking  
Laser Welding  
Sheet Metal  
Machinery  
Manufacturers**



SUBSCRIBE NOW

02:00/03:00

“ WE PARTICIPATE BY ENGIEXPO IN 2020. THE EXPERIENCE WAS GOOD ENOUGH. WE CONSIDER THE EXHIBITION & THE EXHIBITORS CAPACITY BY CONSIDERING ON DOMESTIC LEVEL. IT WAS FANTASTIC EXHIBITION BY ENGIEXPO. ”

**CNC Router  
CNC Milling  
CNC Plasma  
Cutting Machine  
Manufacturer**



SUBSCRIBE NOW

02:00/03:00

“ TO EXPAND OUR BUSINESS, EXHIBITION IS ONE OF THE KEY COMPONENT & ENGIEXPO IS ONE OF THE LARGEST INDUSTRIAL EXPO HAS BEEN COVERING ALL MACHINES & DIFFERENT TYPE OF PRODUCTS TO DISPLAY. BY EXHIBITING IN ENGIEXPO WE WANT TO DISPLAY OUR PRODUCTS. ”

**Flow & Level  
Measuring  
Instruments  
Manufacturers  
and Exporters**



SUBSCRIBE NOW

02:00/03:00

“ WE HAVE PARTICIPATED AT ENGIEXPO 2022 FOR THE SECOND TIME & WE HAVE EXPERIENCE OUR PARTICIPATION WITH ENGIEXPO LAST TIME & WE FOUND THAT IT'S A GOOD PLATFORM TO MEET VARIETY OF PEOPLE. ”

**FIBER LASER  
MACHINE &  
"CO2" LASER  
MACHINE  
MANUFACTURERS  
& SUPPLIERS**



SUBSCRIBE NOW

02:00/03:00

“ WE ARE MANUFACTURER OF MACHINES & WE HAVE LOTS OF CLIENTS SO ENGIEXPO IS ONE OF THE MAIN THING BETWEEN US. & I WANT TO THANK ENGIEXPO FOR GIVING ME A LOTS OF NEW CONTACTS OF CLIENTS. ”

# Customer Feedback

YOUR SUGGESTION FOR IMPROVING THE EVENT & ARRANGEMENTS



No Suggestion because all Arrangements very wonderful.

Name: Karanbirh

Designation: C.E.O

Signature: [Signature]

YOUR SUGGESTION FOR IMPROVING THE EVENT & ARRANGEMENTS



thanks for giving valuable opportunity to grow the Business.

Name: Tirth Patel

Designation: GM

Signature: [Signature]

YOUR SUGGESTION FOR IMPROVING THE EVENT & ARRANGEMENTS



Really very nice arrangements, Everything was well managed & well planned. Good work!! Fully Satisfied.

Name: Jainam Grandh Designation: COO

Signature: [Signature]

YOUR SUGGESTION FOR IMPROVING THE EVENT & ARRANGEMENTS



Its a nice exhibition, and a very good feedback from customer.

Name: Ankit Vadgama

Designation: Manager

Signature: [Signature]

YOUR SUGGESTION FOR IMPROVING THE EVENT & ARRANGEMENTS



Overall Experience with Engrexpa is very good.

Name: Yograj Chudafana Designation: Owner

Signature: YBC

9TH **AHMEDABAD**  
17, 18, 19 December 2022

10TH **SURAT**  
18, 19, 20 February 2023

84TH **RAJKOT**  
17, 18, 19, 20, December 2023

82TH **VADODARA**  
17, 18, 19, February 2024

# Our Past Events



# A MEGA INDUSTRIAL EXHIBITION



- 9TH AHMEDABAD**  
17, 18, 19 December 2022
- 10TH SURAT**  
18, 19, 20 February 2023
- 11TH RAJKOT**  
17, 18, 19, 20, December 2023
- 12TH VADODARA**  
17, 18, 19, February 2024

## SPONSORED BY :



## SOFTWARE PARTNER



## AIR PARTNER



## REGISTRATION PARTNER



## KNOWLEDGE PARTNER



## DIGITAL CARD PARTNER



## MEDIA PARTNER



## EVENT MANAGEMENT PARTNER



## VIDEO FILMS PARTNER



## INFRASTRUCTURE PARTNER



## PRINTING PARTNER



## CAFETERIA PARTNER



## DRINKING WATER PARTNERS



## VENUE PARTNER



## TENDER PARTNER



## SUPPORTED BY :



## JOINTLY ORGANISED BY :



Mktg.Office : 10, Mehta Apartment, 2nd Floor, Above Union Bank, B/s.Radha Vallabh Temple, Jaihind Cross Road, Maninagar, Ahmedabad - 380008, (Guj.)INDIA.  
 Vadodara Add : Hall 1, 1st Floor, Venezia Business Centre, Opp. Zabak Bhavan, Ajwa Road, Vadodara - 390019  
 Mobile : +91- 9687744488 | +91-9879615979 | +91-9879111548  
 Email : engiexpo@gmail.com | Web : www.engiexpo.com  
 BRANCHES : AHMEDABAD | VADODARA | RAJKOT | SURAT